



Eco Edge 100mm Wood Composite Garden Edging

Length 2900mm | Width 16mm | High 100mm



Finishes

- Dark Chocolate
- Dark Grey

Accessories

Straight Joiner

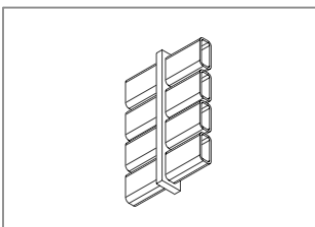

Corner Joiner

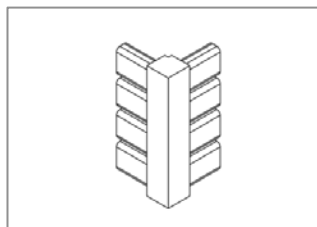

Fixing Spike



Spike Guide





Installation Guide

Eco Edge 100

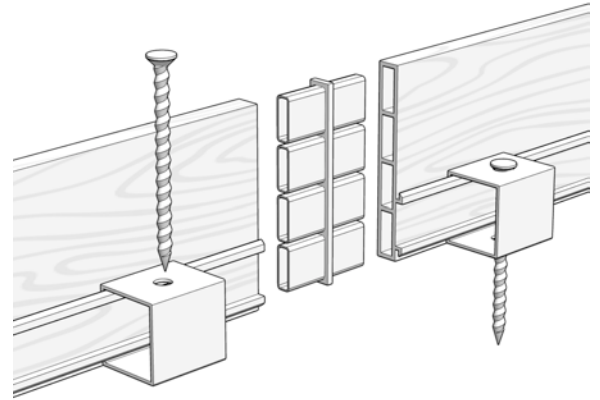

Site Preparation

Hedge can be placed directly onto soil, road base, sand, concrete surfaces & slabs. Site prep required is at the discretion of the installer dependent on above or below ground use.

Joining

Simply insert Hedge custom made straight joiners into the edging profile for a seamless, uninterrupted garden edge.

Cutting

For best results, cut garden edging using an electric drop saw or hand saw. *Metal cutting blade not required.

Fixings

- ✔ Use 4 x 250mm Fixing Spike per length
- ✔ Use 1 x Spike Guide per 250mm spike

Corners

Achieving the perfect right angle is easy with Hedge custom made corner joiners. No additional screws or fixings are required.

Curves

Bend WC edge to the desired shape to create sweeping curves easily.

Step 1 - Join

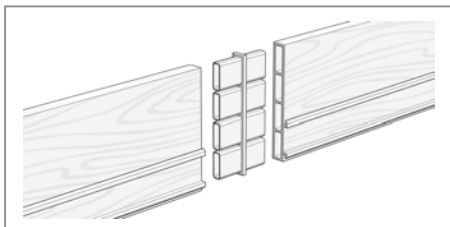

Step 2 - Connect

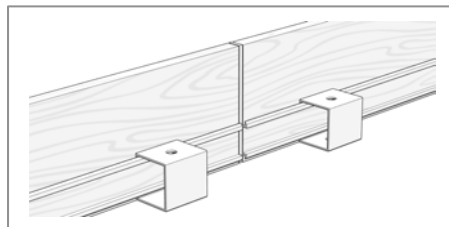

Step 3 - Corners

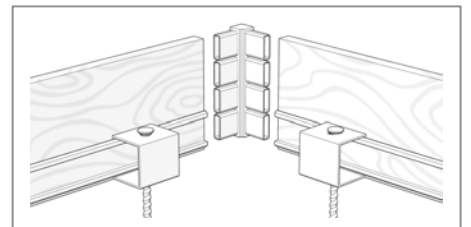

Step 4 - Install

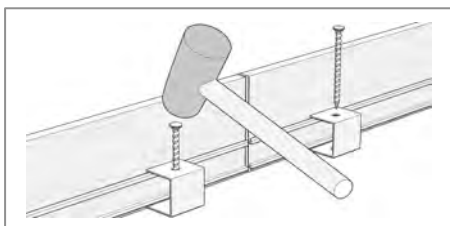

Step 5 - Curves

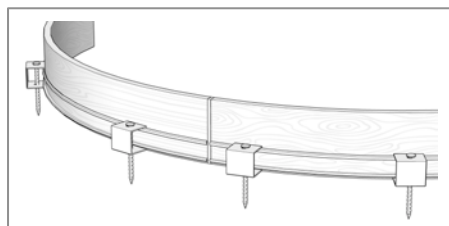

Step 6 - Backfill

